

ATTACHMENT 6
CONTINGENCY PLAN

Table of Contents

1.0 Facility Information 1

2.0 Purpose 1

3.0 Emergency Coordinators 1

4.0 Definitions 1

5.0 Implementation of Contingency Plan 2

 5.1 Assessment/Notification 2

 5.2 Evacuation Plan 2

 5.3 Control Procedures 3

 5.3.1 Spills or Discharges 3

 5.3.2 Explosions 3

 5.3.3 Fires 3

6.0 Prevention of Recurrence or Spread of Fires, Explosions, or Releases 4

7.0 Storage and Treatment of Spilled or Discharged Material 4

8.0 Post-Emergency Equipment Maintenance 4

9.0 Emergency Equipment 4

10.0 Coordination Agreements 4

11.0 Required Reports 7

List of Tables

Table 1- Emergency Call Sheet 10

Table 2 - Emergency Evacuation Route Drawings 11

Table 3 - Emergency Equipment Locations - List of Drawings 22

1.0 FACILITY INFORMATION

Facility Name: Clean Harbors Clive
Facility Operator: Clean Harbors Clive, LLC
Location: 3½ miles south of Milepost 49 (Clive Interchange) on Interstate 80

The facility is designed as a transfer and storage facility of RCRA, TSCA and non-hazardous wastes. Waste is stored in container storage buildings and in other permitted storage areas. Waste is shipped to other off-site locations for treatment or disposal.

2.0 PURPOSE

This Contingency Plan outlines the emergency procedures that will be employed to minimize risks to human health and the environment.

The provisions of this plan will be carried out as specified in Section 5.0.

3.0 EMERGENCY COORDINATORS

Table 1 contains the names of those persons qualified to act as Emergency Coordinators at Clive. All Emergency Coordinators have the authority to call on outside assistance resources to respond to the emergency and to commit requisite resources to implement this plan.

The duties of the Emergency Coordinator are to assess the situation and take steps necessary to protect human health and the environment. The Emergency Coordinator is responsible for the coordination of containment and recovery operations following an emergency or a major emergency.

4.0 DEFINITIONS

Major Emergency: Any explosion, fire, spill, discharge, or natural disaster which has damaged or destroyed, or threatens to damage or destroy, plant property, or impair plant operations, or results in a discharge of waste material into the environment and is beyond the capability of on-site personnel and equipment to control.

Emergency: Similar to a major emergency except that no outside assistance is needed or summoned to deal with the situation. This includes spills or discharges outside of containment areas reportable under Section 11.0 of this plan, explosions, and fires.

Spill or Discharge of hazardous waste : Means the accidental or intentional spilling, leaking, pumping, pouring, emitting, emptying, discharging, injecting, escaping, leaching, dumping of hazardous waste into or on any land or water. This definition applies to all materials that are released (i.e., hazardous and non-hazardous waste, raw materials, by-products, residues, etc.).

Contained Spill or Discharge: A spill or discharge which is contained means that the spill is contained within an area which provides a barrier to prevent a release from contacting the ground or surface waters. This includes paved areas where no runoff occurs, secondary containment structures and the inside of buildings.

Shutdown of Operations: Curtailing site operations by shutting down all waste activities. Buildings are closed to prevent wind or rain from entering, and all unloading operations are ceased. Maintenance and contractor's machinery will be shut down, as needed.

Designated Gathering Points (DGP): The primary designated gathering point (DGP) is located north of the Main Gate, which is on north fence line of the facility. If, due to an emergency the primary DGP is not assessable to all personnel, those employees, contractors and visitors shall meet at the secondary DGP south of the Maintenance Building (Unit 061).

5.0 IMPLEMENTATION OF CONTINGENCY PLAN

The Contingency Plan will be implemented at Clive whenever there is a major emergency, emergency, whenever there is a contained spill or discharge which threatens human health, or any other time the Emergency Coordinator feels it is appropriate. The purpose of this Contingency Plan is to outline the actions which operating personnel will take in response to emergencies, such as fires, explosions, leaks, spills, natural disasters, or discharges of hazardous substances. It establishes guidelines for the orderly handling and reporting of emergency situations which occur or could foreseeably develop at the Clive facility.

5.1 Assessment/Notification

Any person discovering a situation which may require implementation of the Contingency Plan (e.g., fires, spills, etc.) shall immediately warn others working nearby and notify the Emergency Coordinator or Alternate.

The Emergency Coordinator will appraise the situation and determine whether to initiate the Contingency Plan.

The Emergency Coordinator will notify personnel on site of the situation with the use of telephones or cell phones.

Should the situation result in the spill or discharge of hazardous waste, the spill prevention control and countermeasures procedure shall be followed.

If there is a spill or discharge, the worker(s) discovering it will immediately notify the Emergency Coordinator and assess the characteristics of the spill or discharge and promptly initiate a plan to stop the source of the leak. The Emergency Coordinator will initiate measures so as to protect human health and the environment.

Information about waste stored on-site is tracked in the waste-tracking database. All wastes stored on-site are tracked by facility personnel.

5.2 Evacuation Plan

In the event that an evacuation is necessary, on-site personnel will be notified by telephone or cell phone. The evacuation routes should be upwind or crosswind of the emergency and culminate at the designated assembly point(s). The Emergency Coordinator or Alternate will be available by telephone or cell phone and, will announce the appropriate assembly point(s). All personnel not responding to the emergency (visitors and contract personnel) shall evacuate the area and assemble at the appropriate assembly point(s). Table 2 contains the list of the evacuation route drawings. These include evacuation

routes from the buildings and the waste management units at the facility. The evacuation drawings follow Table 2 in this plan.

The facility has a list of all contractors, visitors and truck drivers present at the facility at any given time. A person designated by the Emergency Coordinator at the assembly point(s) during an emergency will notify the Emergency Coordinator of any personnel that are known to be missing from the list. Visitors shall be the responsibility of their Clive contact for accountability.

5.3 Control Procedures

5.3.1 Spills or Discharges

Spilled material will normally be contained in the area where the spill occurs. All spills will be collected and subsequently transferred to permitted storage or to a 90-day accumulation area.

Spills may also occur outside of the containment berms, for example in the case where the containment area has been damaged or in the situation where the spill occurs when the waste is not in a containment area. All material will be kept from entering storm drains, water courses, wells, water systems, and navigable waterways, if possible.

Incompatible wastes are segregated via concrete curbs and containment bays. Thus, the probability of incompatible wastes commingling is not high, and, if possible, spills will be segregated and will be cleaned up immediately to prohibit commingling of wastes.

The following steps are taken to contain and clean up spills and discharges:

- Dress in appropriate protective equipment.
 - Prevent further leaking by repositioning the container, overpacking, or applying a temporary seal to the leak. Simple overpacking for containers is the preferred method.
 - Prevent the spill from spreading by trenching or encircling the area with a dike of sand, absorbent material, or, as a last resort, dirt or rags, or other suitable material. If the spill is in an outside area and it is raining or rain is imminent, cover the spill with plastic sheeting, if feasible.
1. The spill area shall be cleaned up and tested for contamination in accordance with this permit. If the spill area is not in a containment area (i.e., on dirt) the contaminated material will be removed and verification sampling will be conducted.

5.3.2 Explosions

In the event of an explosion, the Emergency Coordinator will immediately shut down all equipment that may be affected. Measures will be implemented to ensure the health and safety of personnel and the environment.

In all cases of an explosion, the Emergency Coordinator must be notified as soon as equipment and waste storage areas are secured.

5.3.3 Fires

In the event of a fire, the automatic sprinkling system will operate and the water cannon system may be activated. Fire extinguishers are located in all buildings. In the event a fire cannot be extinguished using the stationary equipment, fire hoses may be hooked to the hydrants and activated. The water falling on the hazardous waste storage areas will primarily be contained through the containment sump systems.

Unit 101, which functions as a ten-day truck to truck transfer facility, is equipped with a foam suppression system.

6.0 PREVENTION OF RECURRENCE OR SPREAD OF FIRES, EXPLOSIONS, OR RELEASES

During an emergency, the Emergency Coordinator must take all reasonable measures necessary to ensure that additional fires, explosions, and releases do not occur, recur, or spread to other hazardous waste at the facility. These measures must include, where applicable, stopping processes and operations, collecting and containing released waste, and removing or isolating containers.

If the facility stops operations in response to a fire, explosion, or release, the Emergency Coordinator, or his designee, must monitor for leaks, pressure buildup, gas generation, or ruptures in valves, pipes, or other equipment, wherever this is appropriate.

In order to protect the facility from the possibility of range fires, a firebreak surrounds the entire facility.

7.0 STORAGE AND TREATMENT OF SPILLED OR DISCHARGED MATERIAL

Post event sampling and analyses in accordance with Attachment 1, Waste Analysis Plan and Attachment 7, Closure Plan, will be performed after containment, clean-up, and decontamination procedures have been completed.

All spilled or released material will be managed as hazardous waste in accordance with this Permit.

8.0 POST-EMERGENCY EQUIPMENT MAINTENANCE

All equipment used during an emergency, major emergency, or contained spill or discharge will be cleaned and/or replaced, when necessary, to prepare for future use. The emergency equipment will be checked as necessary for completeness and operability in accordance with the Permit.

9.0 EMERGENCY EQUIPMENT

Section 4.0 of the Preparedness and Prevention Plan, Attachment 5, lists the emergency equipment at the site along with a physical description of its capabilities. Table 3 of this Attachment is a listing of drawings showing the locations of the minimum emergency equipment at Clive. The drawings follow Table 3.

10.0 COORDINATION AGREEMENTS

Clean Harbors Clive has negotiated a written agreement with Tooele County. Representatives of Tooele County have been contacted, have received a copy of this Contingency Plan, and have received a plant walk-through to familiarize them with the plant layout and function. Annual re-orientation is offered at the plant site for Tooele County representatives. By the terms of the written agreement, Tooele County has agreed to provide the following services:

- Tooele County road maintenance,
- Routine law enforcement,
- Fire response,
- Public health,
- Public safety, and
- Hospital isolation unit

Clean Harbors Clive has also negotiated agreements with other local agencies to provide assistance in the event that additional equipment and manpower are required at the facility. Representatives of each agency below have been contacted. Each has received a copy of this Contingency Plan and has received a plant walk-through to familiarize each agency with the plant layout and function. Also, annual re-orientation is offered at the plant site to the following agencies:

Tooele County Sheriff's Department*
Tooele, Utah
435-882-5600

Tooele Emergency Management
435-843-3263

* The Sheriff's Department is the designated primary coordinating agency.

The following organizations may be notified of an emergency condition if appropriate.

Emergency Services	Business Number	Emergency Number
West Wendover Fire Department₁	(775) 664-2274	Dispatch (775) 664-4393 or 911
West Wendover Police Department	(775) 664-2930	
West Wendover Ambulance₁	(775) 664-2081	
Air Medical Evacuation₁ University of Utah Hospital Helicopter	(801) 581-7200	Dispatch (801) 581-2500 or 911
Life Flight LDS Hospital	(801) 321-3330	Dispatch (801) 321-1234 or 911
North Tooele County Fire District₁	(435) 882-6730	Dispatch (435) 882-5600 or 911
Grantsville Fire Department	(435) 884-3343	
Grantsville Police Department	(435) 884-6881	
Grantsville Ambulance	(435) 882-5600	
Tooele County Sheriff¹	(435) 882-5600	
Tooele Police Department	(435) 882-8900	
Tooele Ambulance	(435) 882-5600	
National Poison Control	1-800-222-1222	
National Response Center	1-800-424-8802	
Utah Division of Waste₁ Management and Radiation Control	(801) 536-0200	(801) 536-4123
Clean Harbors Corporate Office	(781) 792-5000	
U.S. EPA Region VIII	(303) 312-6312	
Utah Highway Patrol	(801) 965-4518	
3E	(800)360-3220	
Bureau of Land Management	(801)-977-4300	

This plan will be reviewed annually, updated as necessary, and forwarded to Tooele County's Department of Emergency Management and Department of Engineering.

¹ *Provided with a copy of this Plan.*

11.0 REQUIRED REPORTS

As required by R315-264-56(d)(2), for major emergencies, Clean Harbors Clive shall immediately notify the Utah State Department of Environmental Quality. The report will include:

- Name and telephone number of reporter,
- Name and address of facility,
- Time and type of incident, e.g., discharge, fire,
- Name and quantity of material(s) involved, to the extent available,
- The extent of injuries, if any, and
- The possible hazards to human health or the environment, outside the facility.

As required by R315-264-56(i), Clean Harbors Clive will document in the operating record any incident that requires implementing this Contingency Plan. In addition, Clean Harbors Clive will submit a written report to the Director of the Division of Waste Management and Radiation Control within 15 days after an incident that required implementation of the Contingency Plan. The report will include:

- Name, address, and telephone number of the owner or operator,
- Name, address, and telephone number of the facility,
- Date, time, and type of incident,
- Name and quantity of material(s) involved,
- The extent of injuries, if any,
- An assessment of actual or potential hazard to health or the environment, and
- Estimated quantity and disposition of recovered material that resulted from the incident.

For spills which require reporting under R315-263-30, Clean Harbors Clive shall immediately notify the Utah State Department of Environmental Quality. The report will include:

- Name, telephone number, and address of person responsible for the spill,
- Name, title, and telephone number of individual reporting,
- Time and date of spill,
- Location of spill,
- Description contained on the manifest and the amount of material spilled,
- Cause of spill, and
- Emergency action taken to minimize the threat to human health and the environment.

As required by R315-263-33, Clean Harbors Clive will submit a written report to the Director within 15 days for spills which become hazardous waste and must be reported under Utah Admin. Code R315-263-30(b). This report will include:

- The person's name, address, and telephone number,
- Date, time, location, and nature of incident,
- Name and quantity of material(s) involved,
- The extent of injuries, if any,
- An assessment of actual or potential hazards to human health or the environment, where this is applicable, and
- The estimated quantity and disposition of recovered material that resulted from the incident.

Contained spills or discharges that do not threaten human health need not be reported. However, they shall be recorded in the operating record.

As required by R315-263-30(d), spills on site involving reportable quantities (RQ) will be reported to the National Response Center. They will also be reported to the Utah Division of Waste Management and Radiation Control (DWMRC), Tooele County Office of Engineering and Department of Emergency Management, and the U.S. EPA, Region VIII.

If plant operations were suspended due to Contingency Plan implementation, Clive may only resume operations once the Emergency Coordinator has determined that all safety-related questions have been satisfactorily addressed. Clive shall notify EPA and DWMRC that the facility is in compliance with the Permit and R315-264-56(h) prior to resuming operations.

Reports to the Director of DWMRC shall be sent to:

Director
Utah Division of Waste Management and Radiation Control
P.O. Box 144880
Salt Lake City, Utah 84114-4880

Or hand delivered to

Director
Utah Division of Waste Management and Radiation Control
195 North 1950 West
Salt Lake City, Utah 84116

Reports to EPA Region VIII shall be submitted to:

Regional Administrator
U.S. EPA - Region VIII
1595 Wynkoop Street
Denver, Colorado 80202

Reports to Tooele County shall be submitted to:

Tooele County
Department of Emergency Management and
Department of Engineering
47 South Main
Tooele, Utah 84074

Immediate reporting of certain events to the Utah Department of Environmental Quality, as outlined in this section, shall be made to the following:

Utah Division of Waste Management and Radiation Control
(801) 536-0200 (during office hours); or

Utah Department of Environmental Quality
(801) 536-4123 (24-hour answering service)

Table 1

EMERGENCY CALL SHEET

Clive Emergency Coordinators

Position	Name	Telephone Numbers
Primary	Branden Prettyman	435-884-8573 (Office) 435-840-5469 (Cell)
Alternate	Chris Krish	435-884-8424 (Office) 435-841-1842 (Cell)
Alternate	Chris Bjerke	435-884-8570 (Office) 801-831-5368 (Cell)

Table 2
Emergency Evacuation Route Drawings

Description	Drawing No.	Date
Emergency Employee Evacuation Routes for the Rail -To - Trailer Transfer Station Unit 255 & Rail Scales Unit 055	EE-99-3-018 Rev 0	10-14-16
Emergency Employee Evacuation Routes for the Containerized Bulk Solids Storage Unit 106	EE-99-3-032 Rev 0	10-14-16
Emergency Employee Evacuation Routes for the Security Office Unit 051 & Admin /Truck Scale Unit 054	EE-43-99-3-004 Rev 0	10-14-16
Emergency Employee Evacuation Routes for the Thaw Unit 105	EE-99-3-013 Rev 0	10-14-16
Emergency Employee Evacuation Routes for the Waste Fuel Tank Farm Rail Tanker Unloading Area Unit 535	EE-99-3-023 Rev 0	10-04-16
Emergency Employee Evacuation Routes for the Container Management Building Unit 101	EE-DECON-101 Rev 0	10-14-16
Emergency Employee Evacuation Routes for the Warehouse Building Unit 102	EVAC102 Rev 0	5-17-21
Emergency Employee Evacuation Routes for the Raw Water / Eire Water Storage Tank Unit 031 Fire Water Pump Building 038 & MCC Unit 076	EE-99-3-001 Rev 0	10-14-16
Emergency Employee Evacuation Routes for the Truck Wash Building Unit 604 &. MCC Unit 80	EE-99-3-029 Rev 0	10-14-16
Emergency Employee Evacuation Routes	43-99-3-054 Rev 1	10-14-16
Emergency Employee Evacuation Routes for the Maintenance Building Unit 061 -- Grade	EE-99-3-007A Rev 0	10-14-16

C:\Users\myerem2\Documents\Work\Clive\Employee Evacuation Routes\EE-99-3-018, Rev 0 (Bldg 255 & 055).DWG

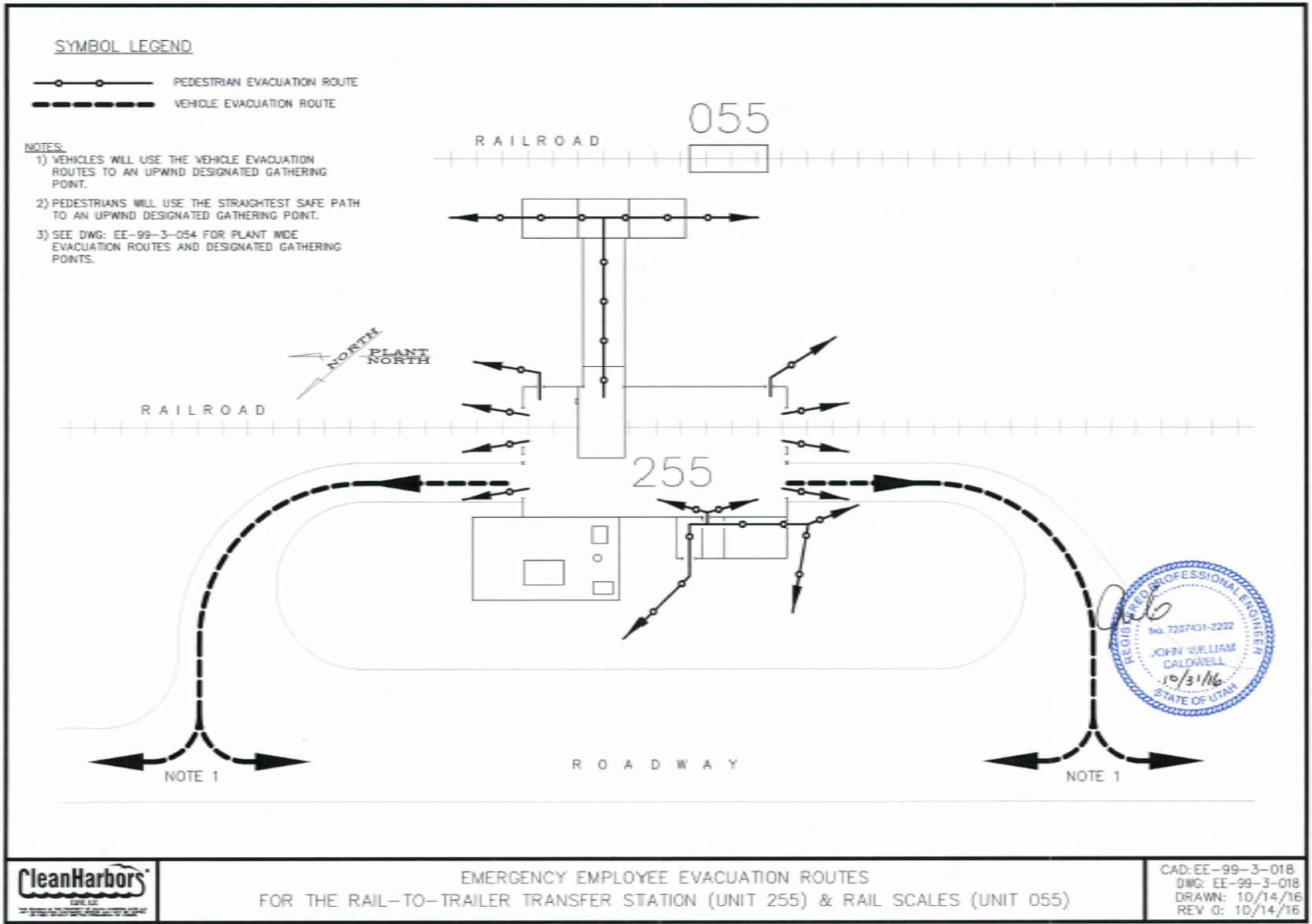

C:\Users\myersm2\Documents\Work\Clive\Employee Evacuation Routes\EE-99-3-032, Rev 0 (Bldg 106).DWG

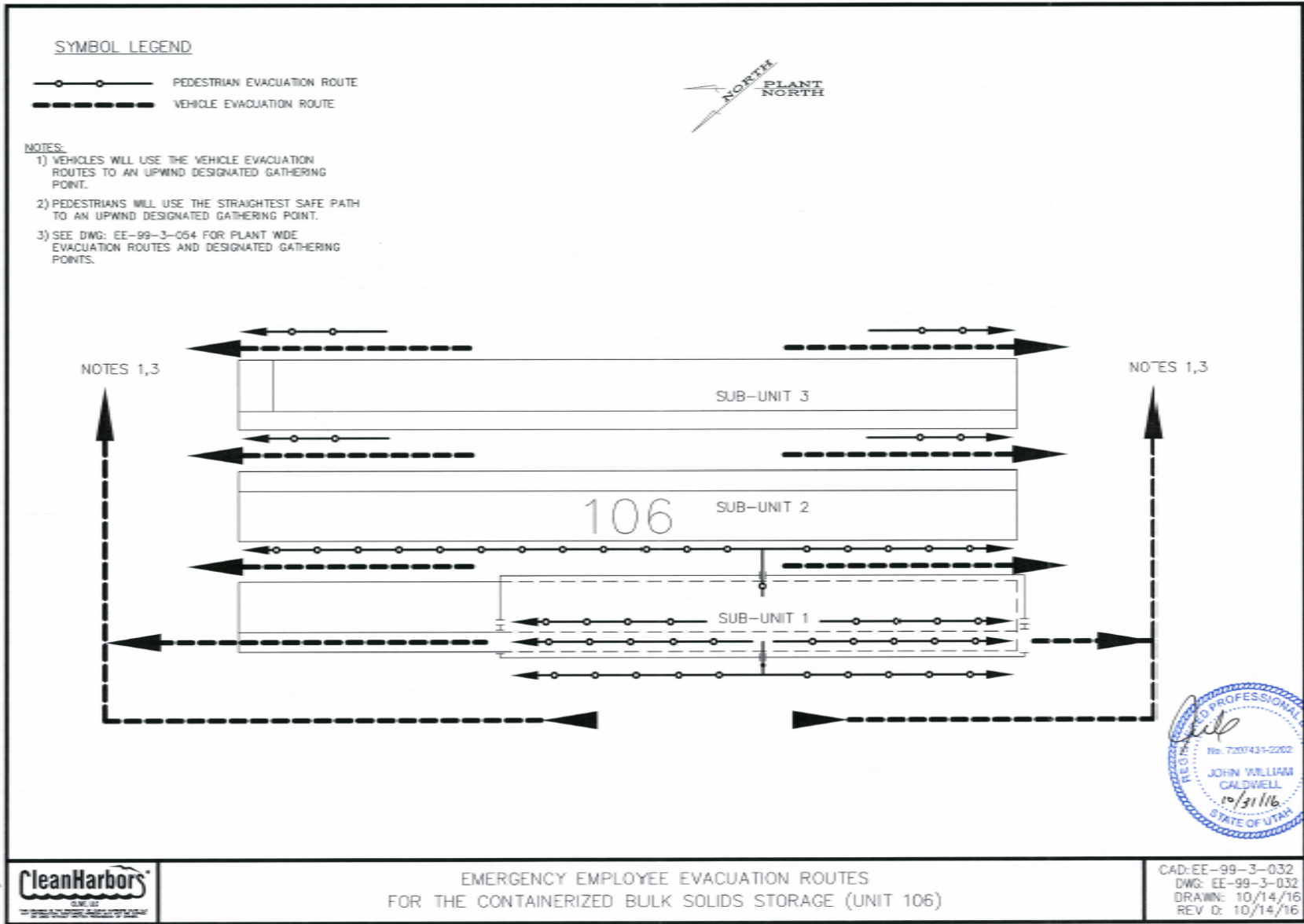

C:\Users\myersm2\Documents\Work\Clive\Employee Evacuation Routes\EI-43-99-3-004, Rev 3 (Bldg 051 & 054).dwg

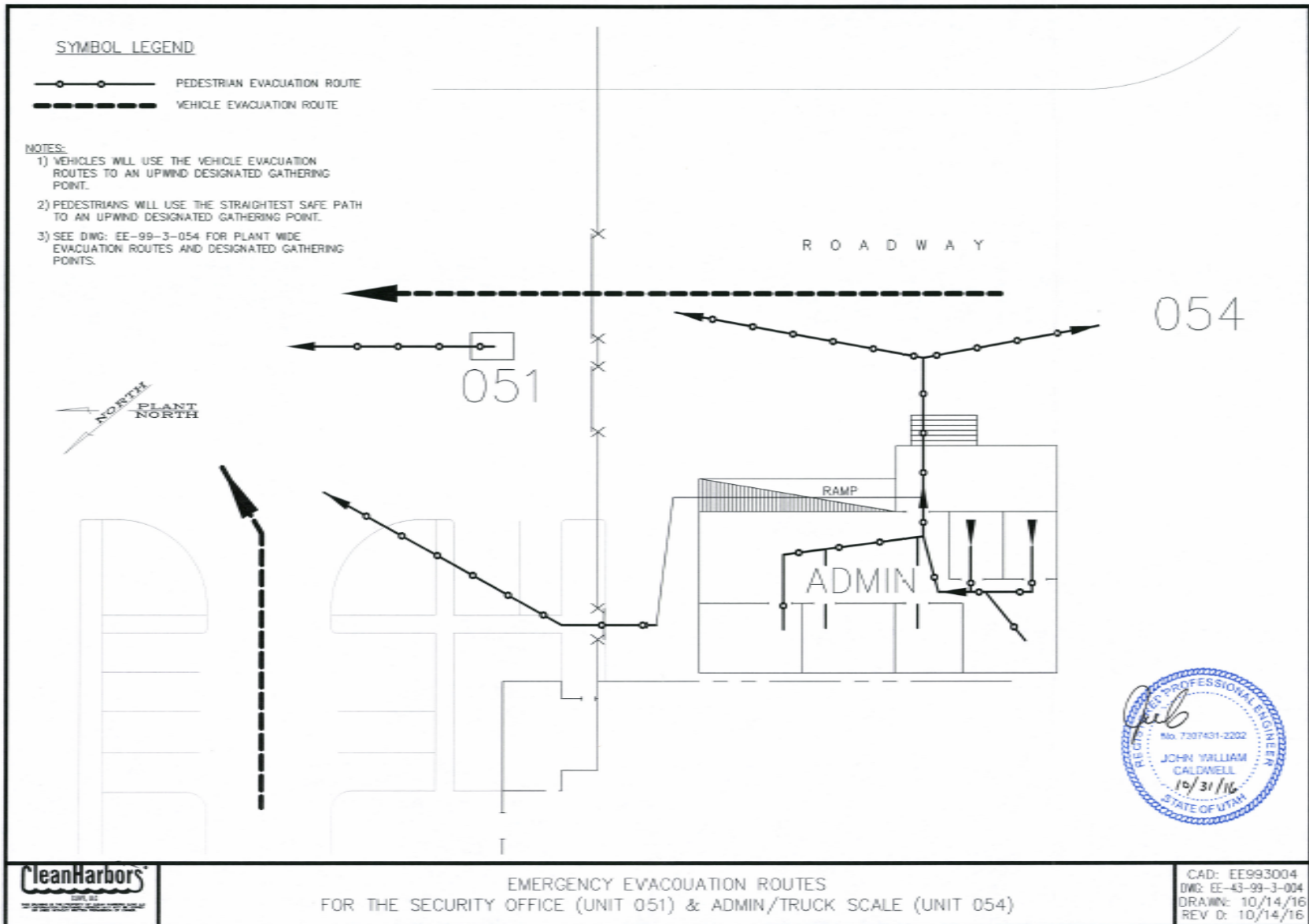

C:\Users\myerem2\Documents\Work\Clive\Employee Evacuation Routes\EE-99-3-013, Rev 0 (Bldg 105).DWG

SYMBOL LEGEND

-  PEDESTRIAN EVACUATION ROUTE
-  VEHICLE EVACUATION ROUTE



NOTES:

- 1) VEHICLES WILL USE THE VEHICLE EVACUATION ROUTES TO AN UPWIND DESIGNATED GATHERING POINT.
- 2) PEDESTRIANS WILL USE THE STRAIGHTEST SAFE PATH TO AN UPWIND DESIGNATED GATHERING POINT.
- 3) SEE DWG: EE-99-3-054 FOR PLANT WIDE EVACUATION ROUTES AND DESIGNATED GATHERING POINTS.

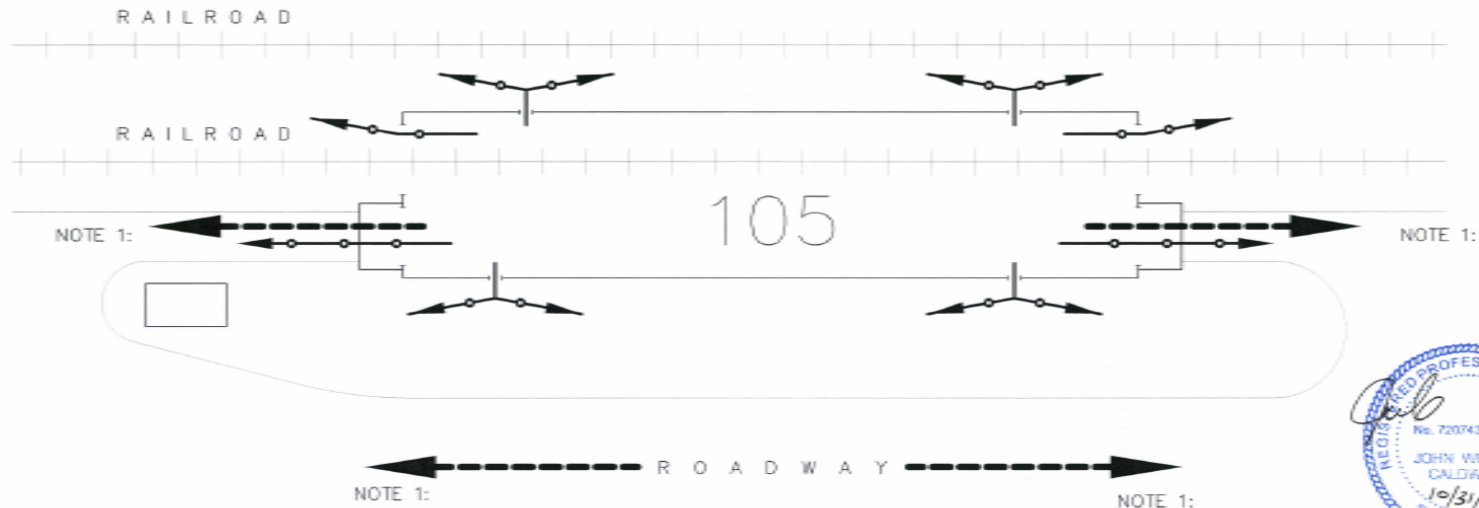

EMERGENCY EMPLOYEE EVACUATION ROUTES
FOR THE THAW UNIT (UNIT 105)

CAD: EE-99-3-013
DWG: EE-99-3-013
DRAWN: 10/14/16
REV 0: 10/14/16

C:\Users\myersm2\Documents\Work\Clive\Employee Evacuation Routes\EE-99-3-023, Rev 0 (Bldg 535).DWG

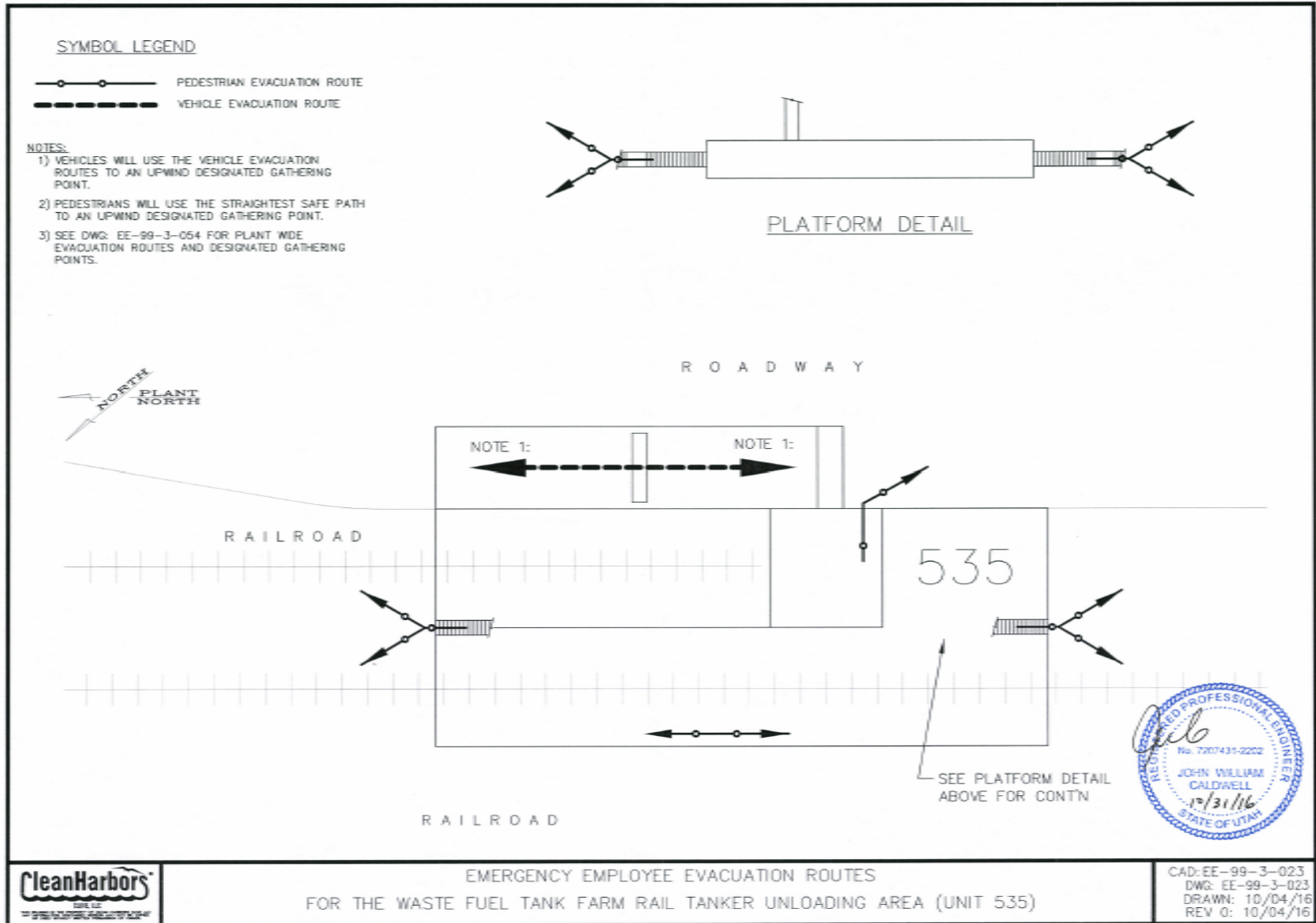

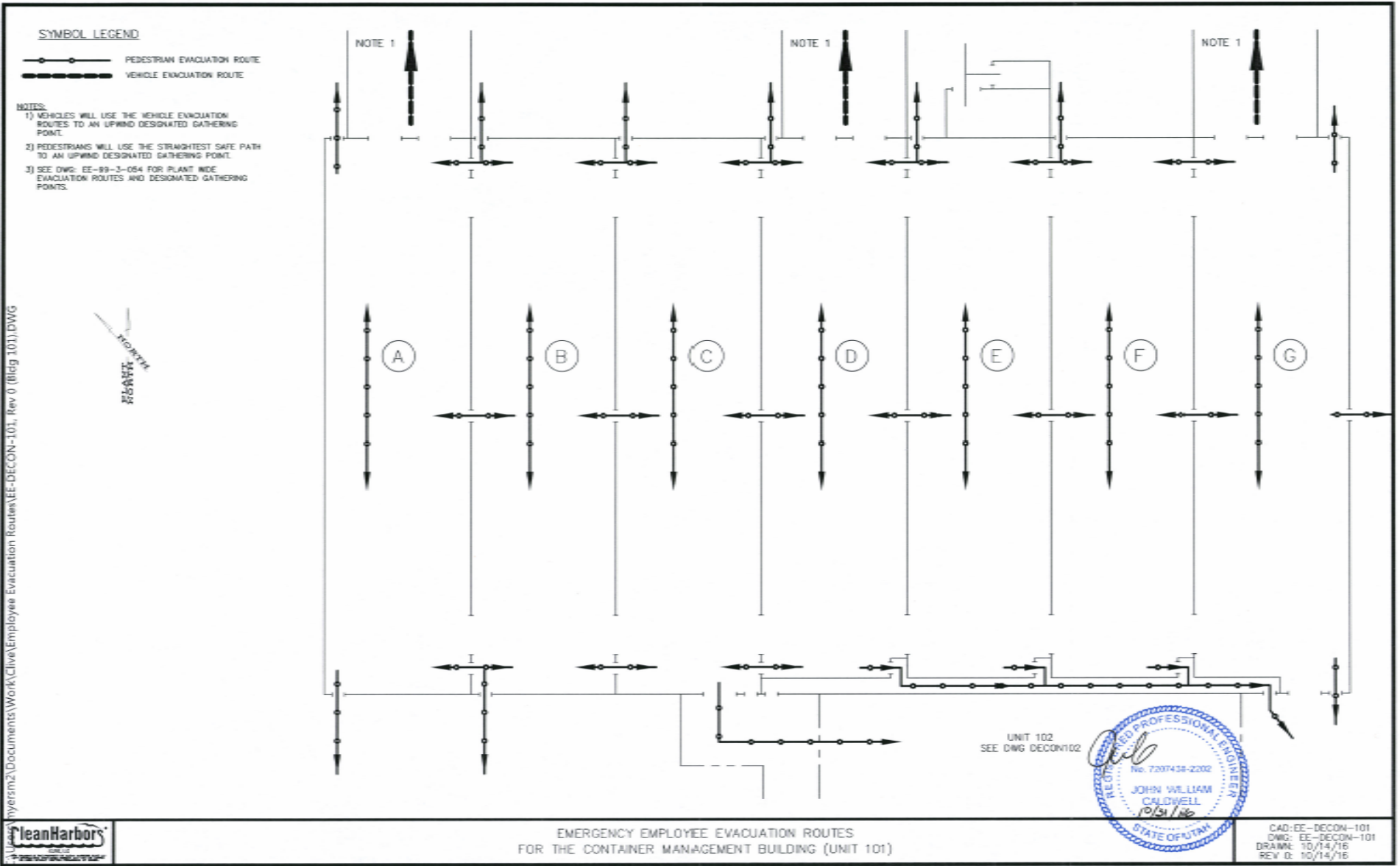

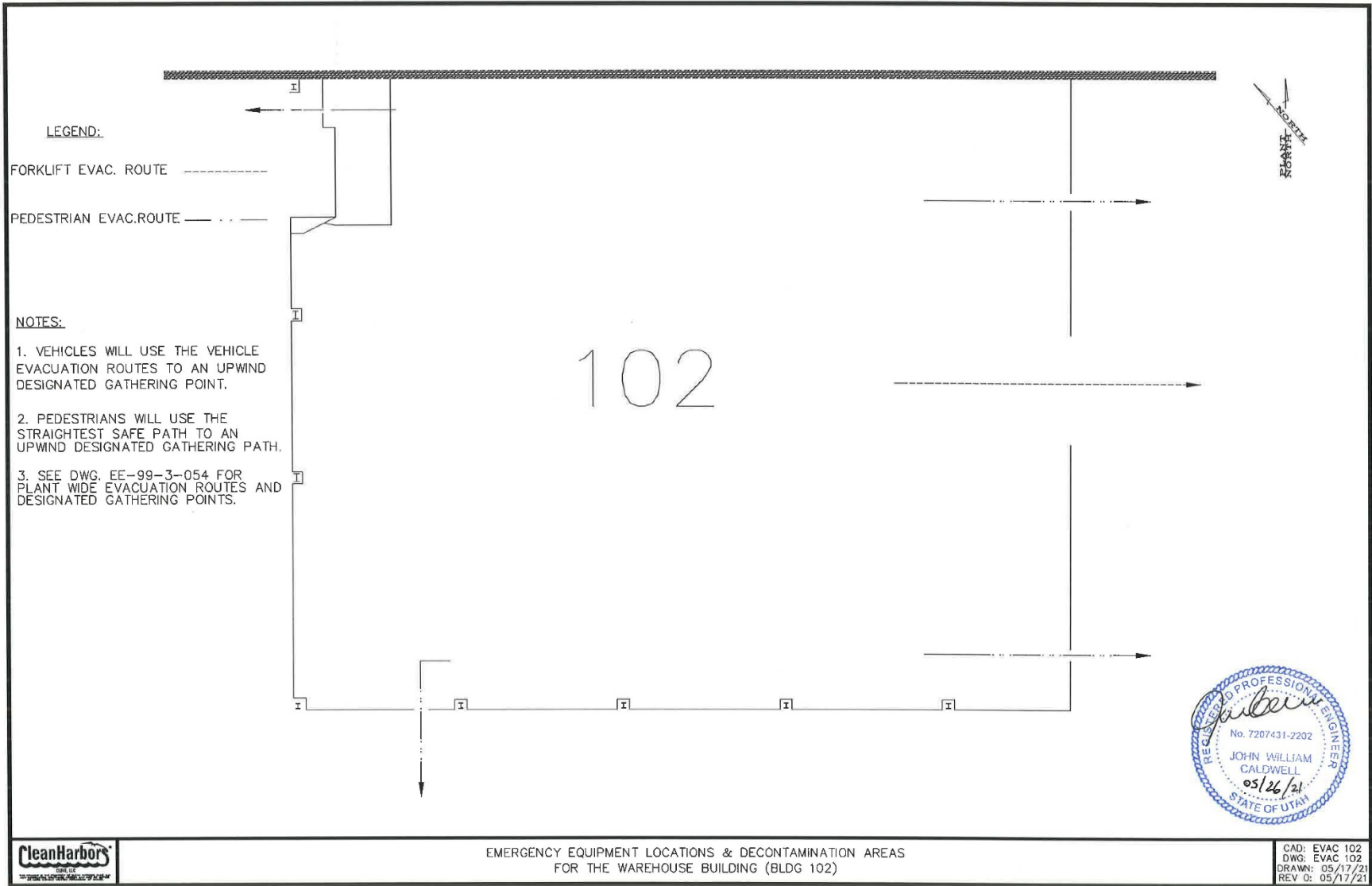

C:\Users\myersm2\Documents\Work\Clive\Employee Evacuation Routes\EE-99-3-001, Rev 0 (Raw and Fire Water building 38).DWG

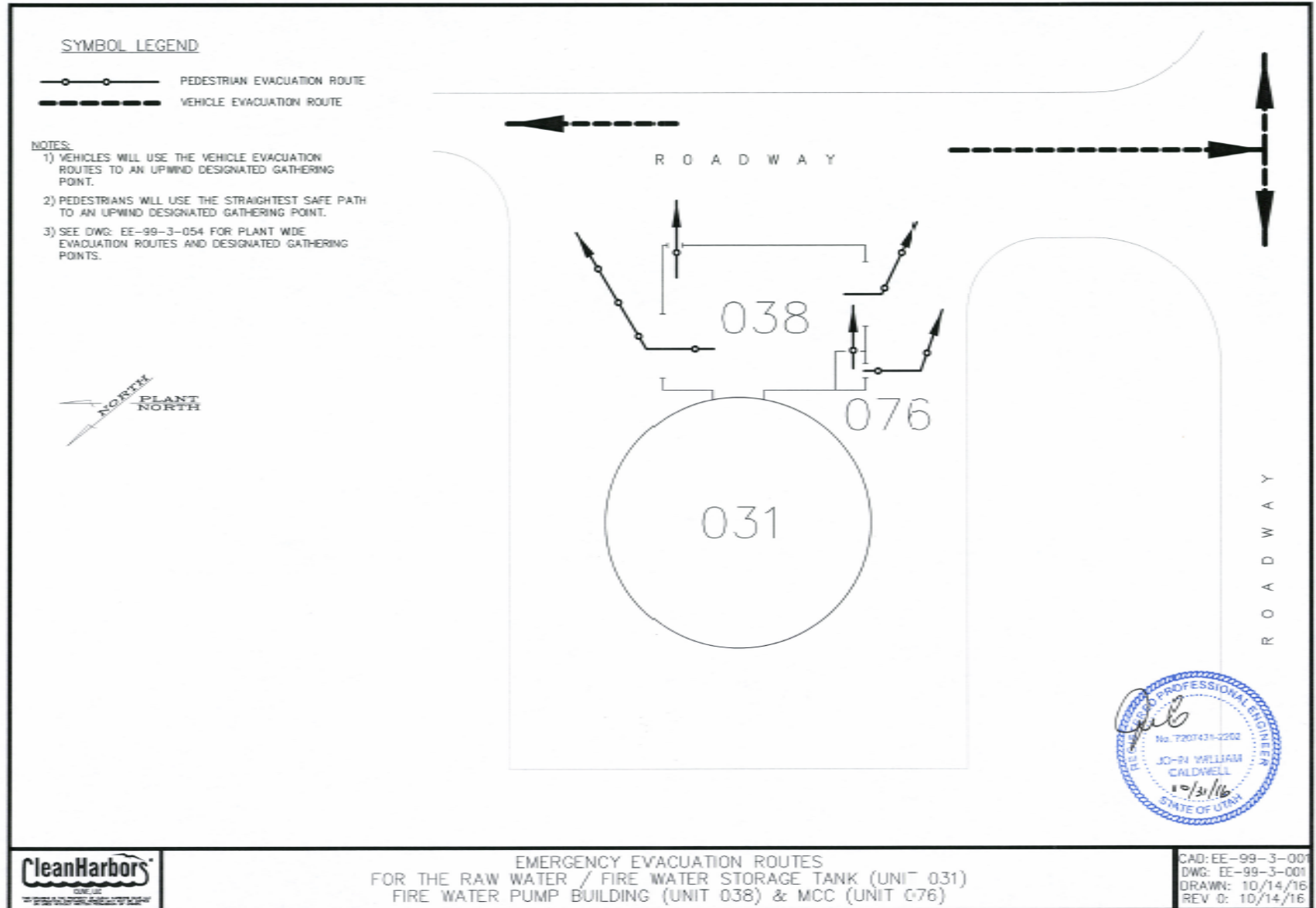

C:\Users\myersm2\Documents\Work\Clive\Employee Evacuation Routes\EE-99-3-029, Rev 0 (Bldg 604).DWG

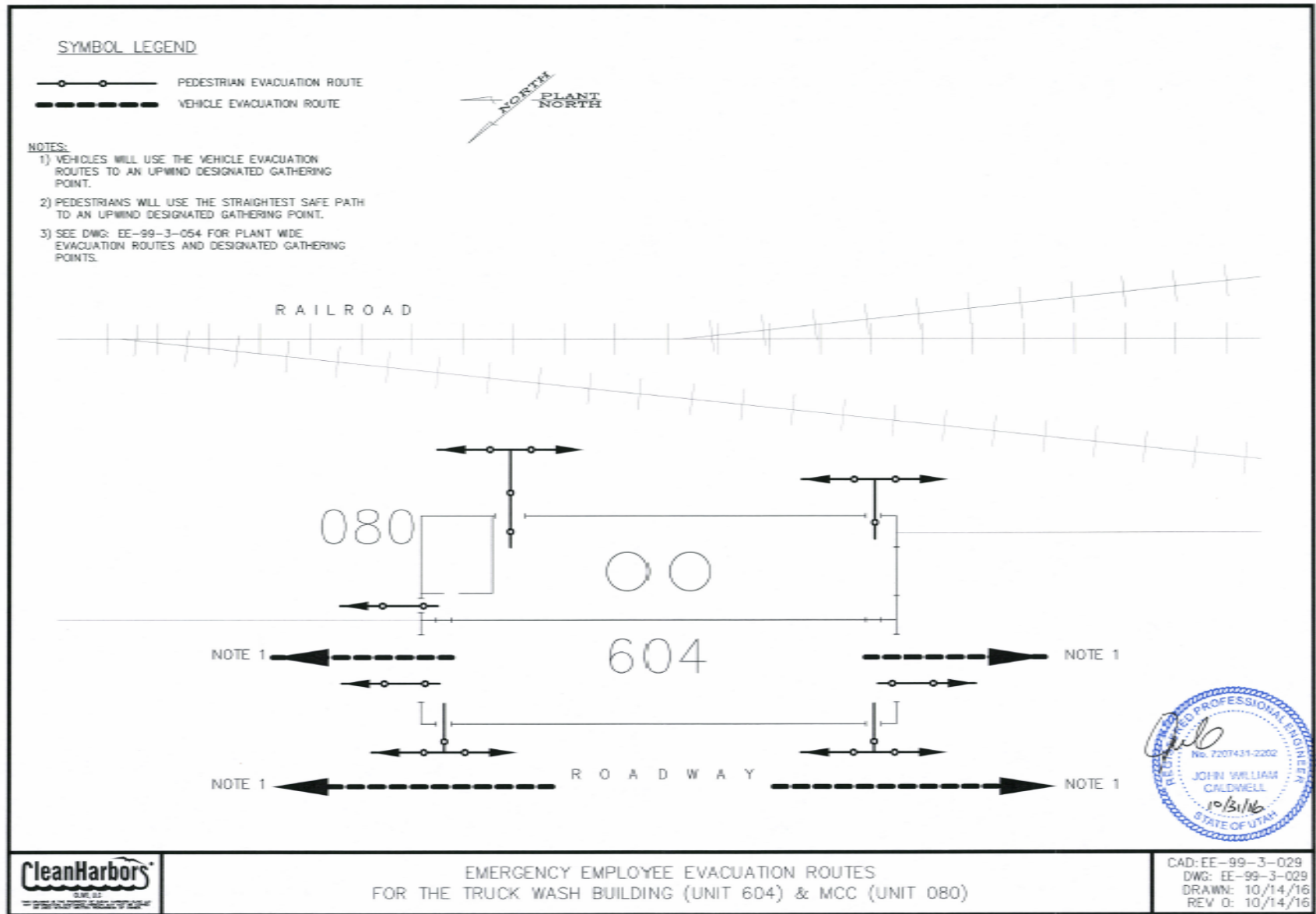

C:\Users\myerem2\Documents\Work\Clive\43-99-3-054_Rev 1 (Plantwide Emergency Evacuation Routes).DWG

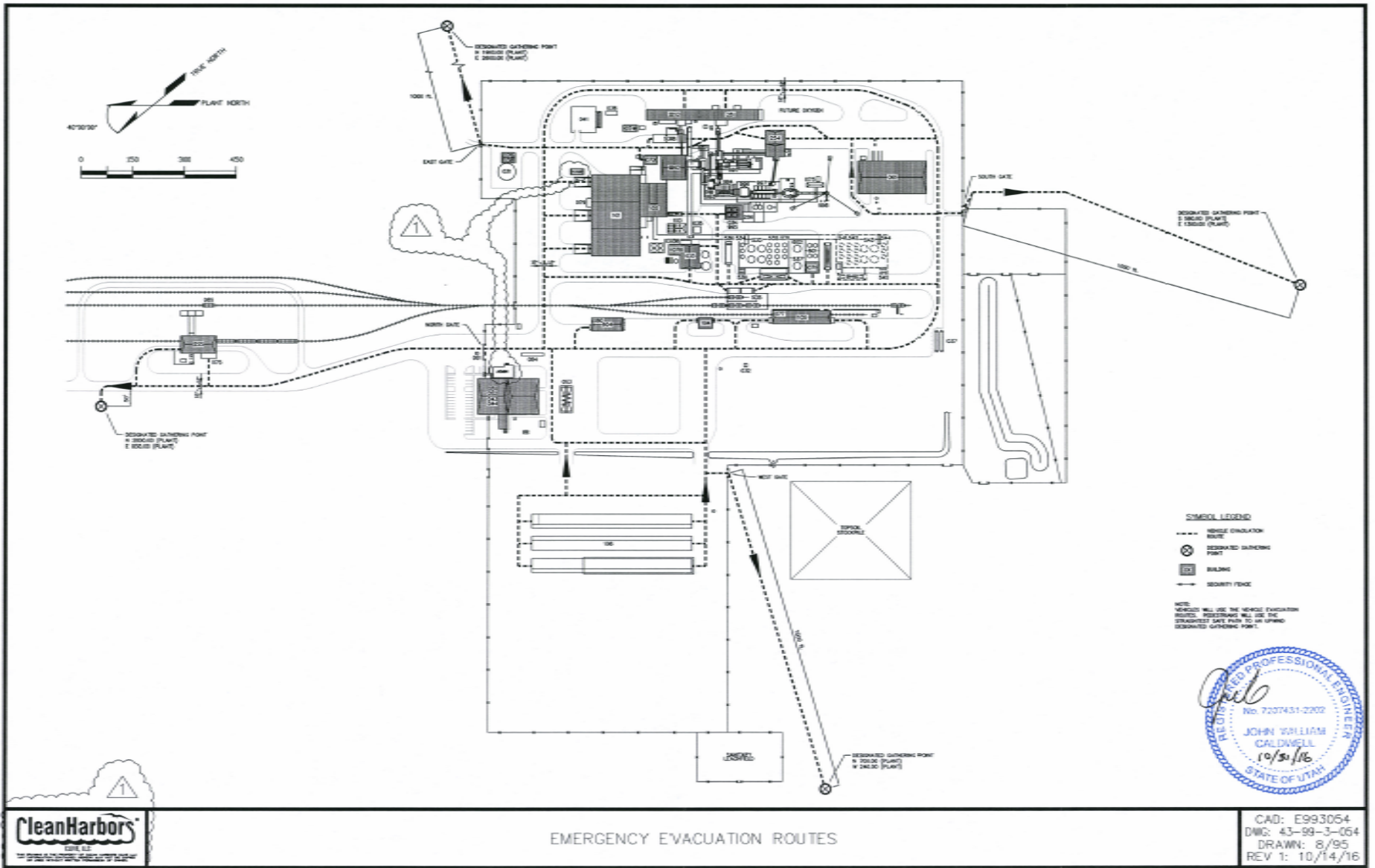

C:\Users\myersm2\Documents\Work\Clive\Employee Evacuation Routes\EE-99-3-007A_Rev 0 (Bldg 061, Grade).DWG

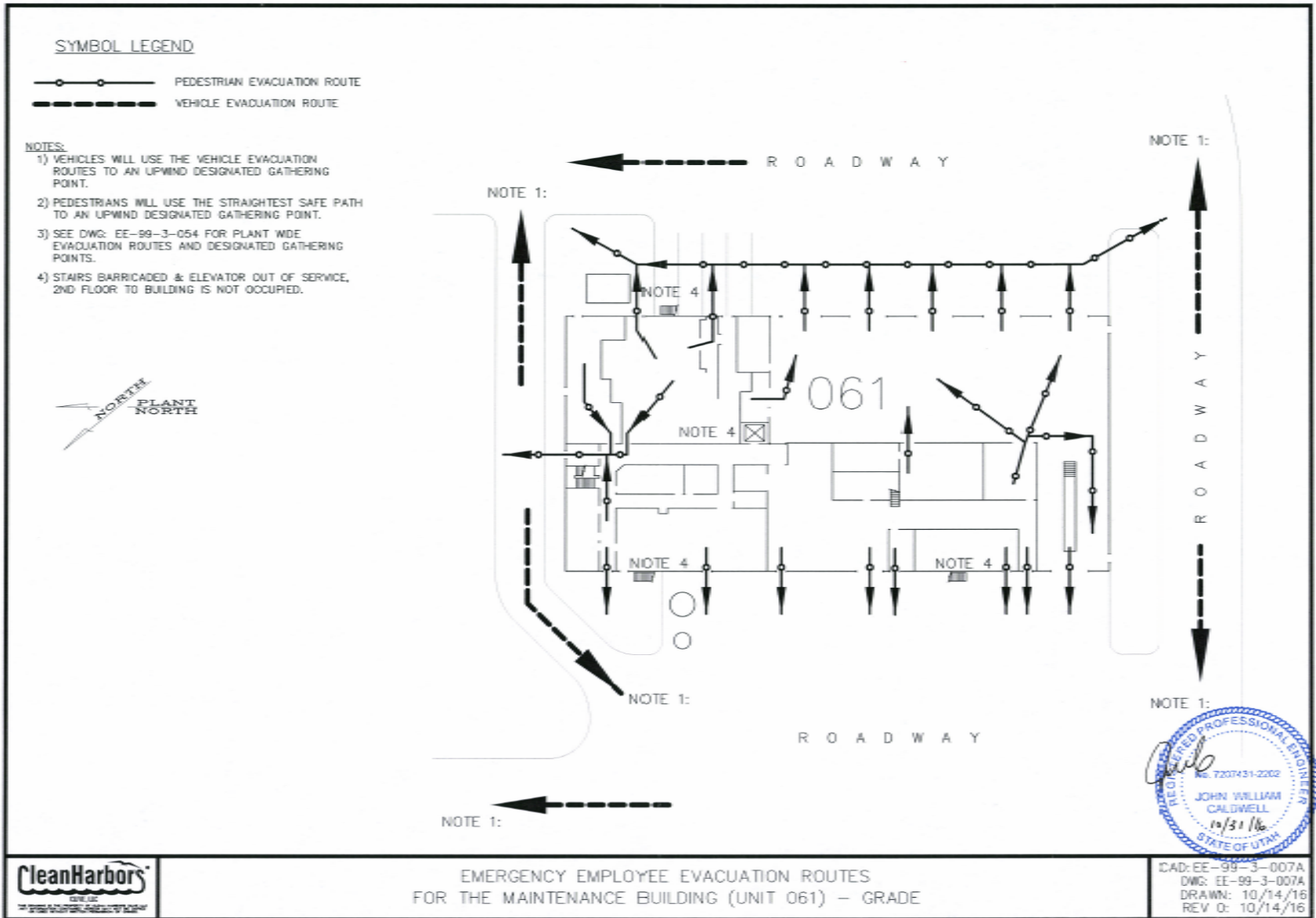
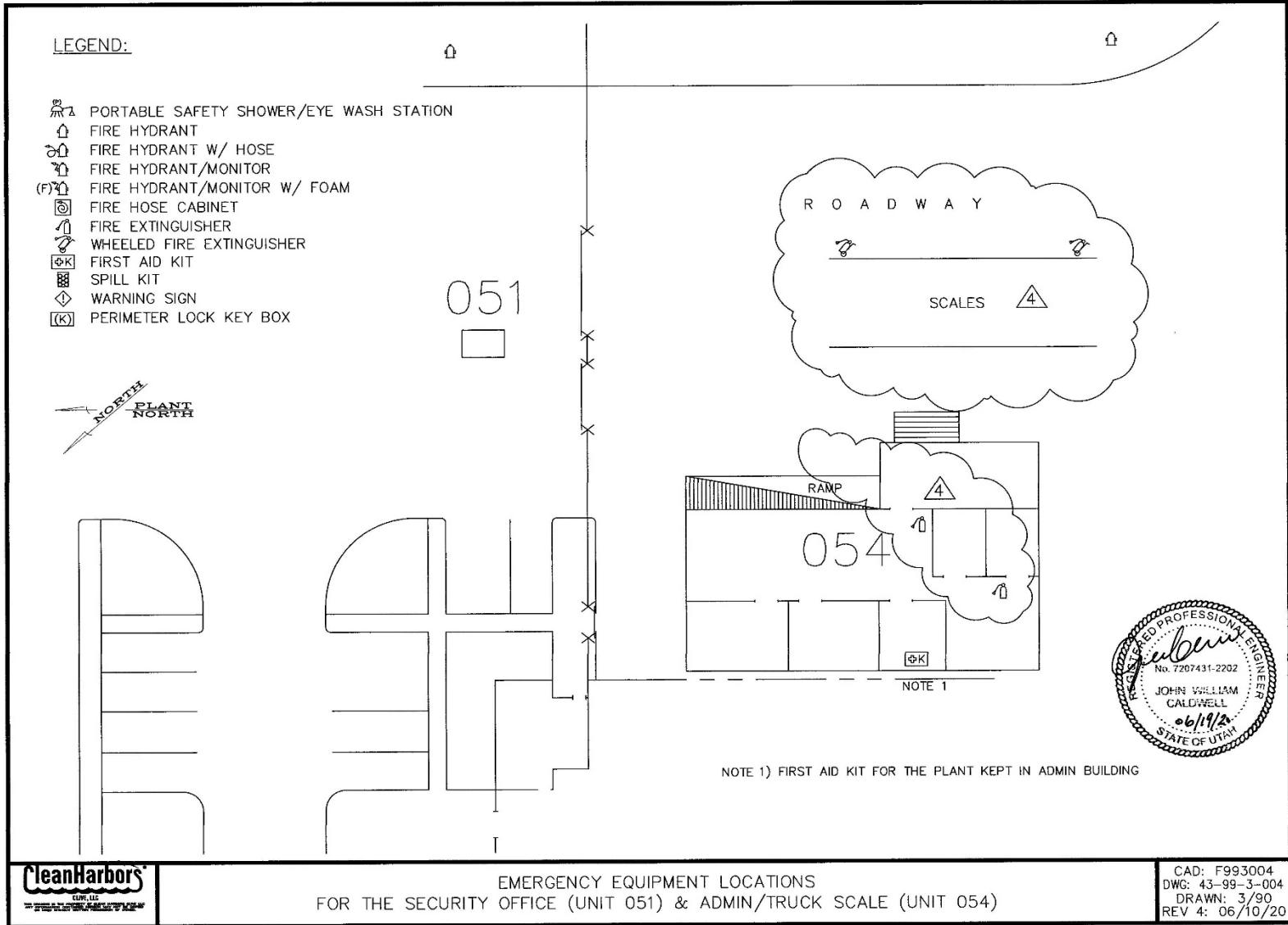













Table 3Emergency Equipment Location Drawings

Description	Drawing No.	Date
Emergency Equipment Locations for Unit 051 & Admin/Truck Scale Unit 054	43-99-3-004 Rev 4	06-10-20
Emergency Equipment Locations for the Thaw Unit 105	43-99-3-013 Rev 6	06-10-20
Emergency Equipment Locations for the Truck Wash Building unit 604 & MCC Unit 080	43-99-3-029 Rev 6	06-10-20
Emergency Equipment locations for the Raw Water / Fire Water Storage Tank 031, Fire Water Pump Building 038 & MCC 076	43-99-3-001 Rev 3	06-10-20
Emergency Equipment Locations for the Containerized Bulk Solids Storage Unit 106	43-99-3-032 Rev 5	06-10-20
Emergency Equipment Locations & Decontamination Areas for the Container Management Building Unit 101	DECON101 Rev 1	06-10-20
Emergency Equipment Locations & Decontamination Areas for the Warehouse Building Unit 102	DECON102 Rev 0	5-17-2021
Emergency Equipment Locations for the Maintenance Building Unit 061 - Grade	43-99-3-007A Rev 4	06-10-20
Emergency Equipment Locations for the Intermodal Container Staging & Transfer Unit 104	43-99-3-012 Rev 4	10-06-16
Emergency Equipment Locations for the Waste Fuel Tank Farm Rail Tanker Unloading Area Unit 535	43-99-3-023 Rev 6	06-10-20
Emergency Equipment Locations for the Rail - To- Trailer Transfer Station Unit 255 & Rail Scales Unit 055	43-99-3-018 Rev 5	06-10-20



LEGEND:

-  PORTABLE SAFETY SHOWER/EYE WASH STATION
-  FIRE HYDRANT
-  FIRE HYDRANT W/ HOSE
-  FIRE HYDRANT/MONITOR
-  FIRE HYDRANT/MONITOR W/ FOAM
-  FIRE HOSE CABINET
-  FIRE EXTINGUISHER
-  FIRST AID KIT
-  SPILL KIT
-  WARNING SIGN
-  PERIMETER LOCK KEY BOX

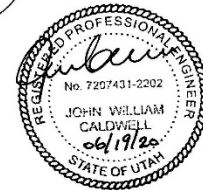
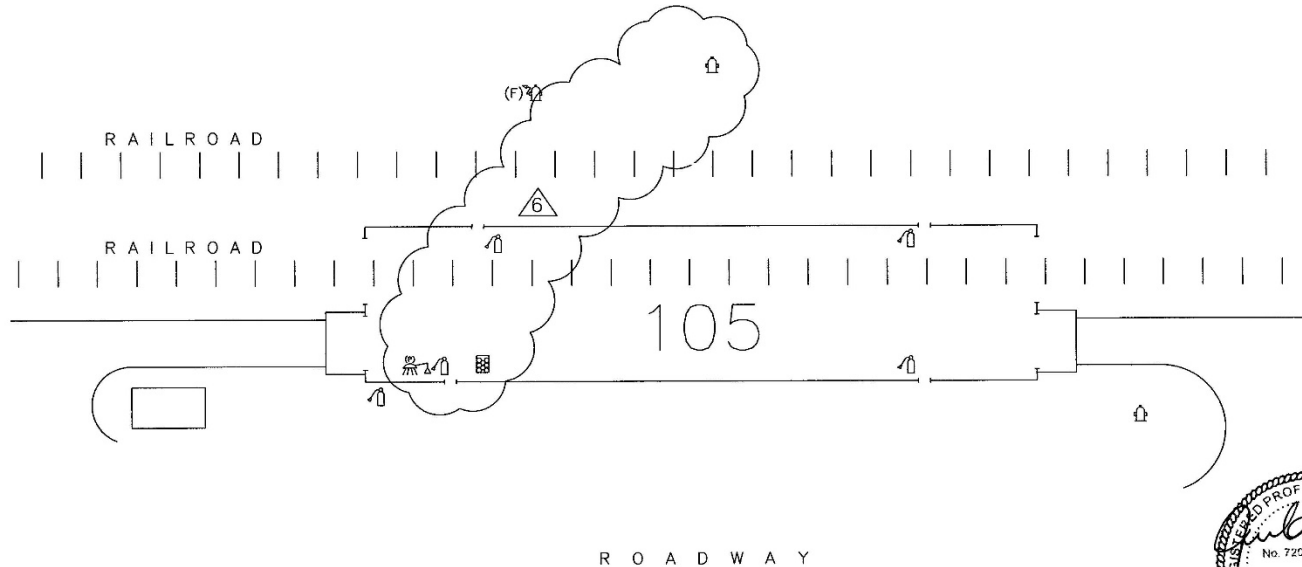

EMERGENCY EQUIPMENT LOCATIONS
FOR THE THAW UNIT (UNIT 105)



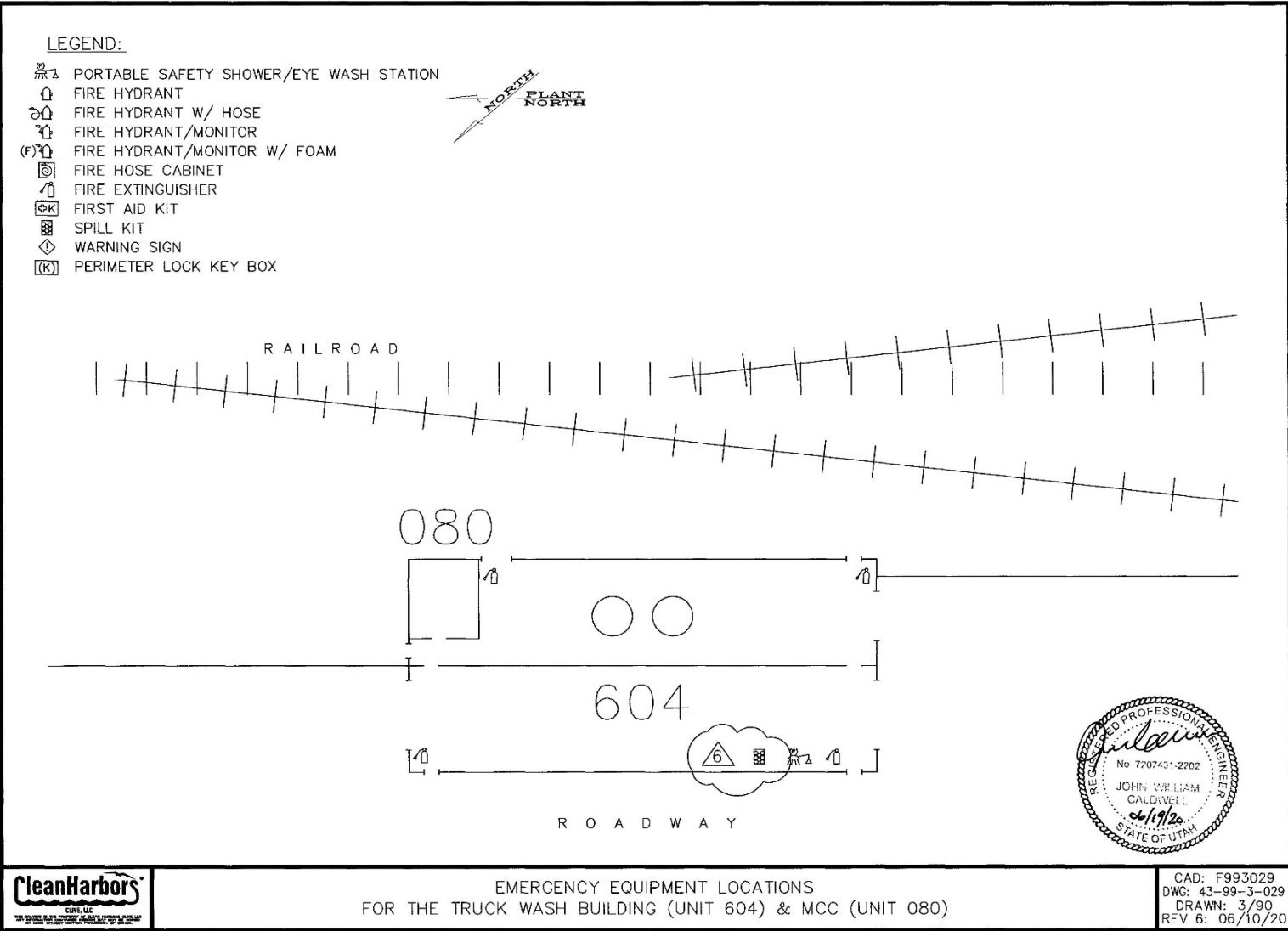







CAD: F993013
DWG: 43-99-3-013
DRAWN: 3/90
REV 6: 06/10/20



UNIT 052
SEE DWG 43-99-3-005A



LEGEND:

-  PORTABLE SAFETY SHOWER/EYE WASH STATION
-  FIRE HYDRANT
-  FIRE HYDRANT W/ HOSE
-  FIRE HYDRANT/MONITOR
-  FIRE HYDRANT/MONITOR W/ FOAM
-  FIRE HOSE CABINET
-  FIRE EXTINGUISHER
-  FIRST AID KIT
-  SPILL KIT
-  WARNING SIGN
-  PERIMETER LOCK KEY BOX

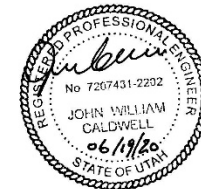
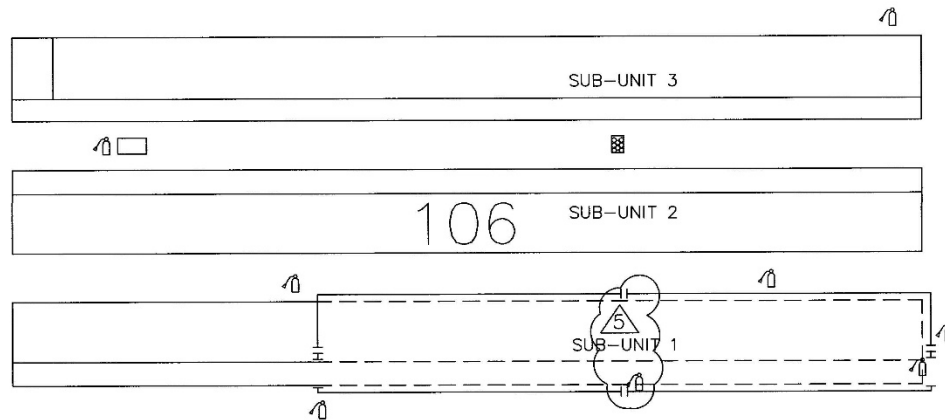
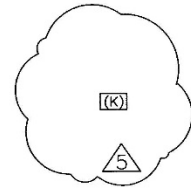

EMERGENCY EQUIPMENT LOCATIONS
FOR THE CONTAINERIZED BULK SOLIDS STORAGE (UNIT 106)

CAD: F993032
DWG: 43-99-3-032
DRAWN: 1/94
REV 5: 06/10/20

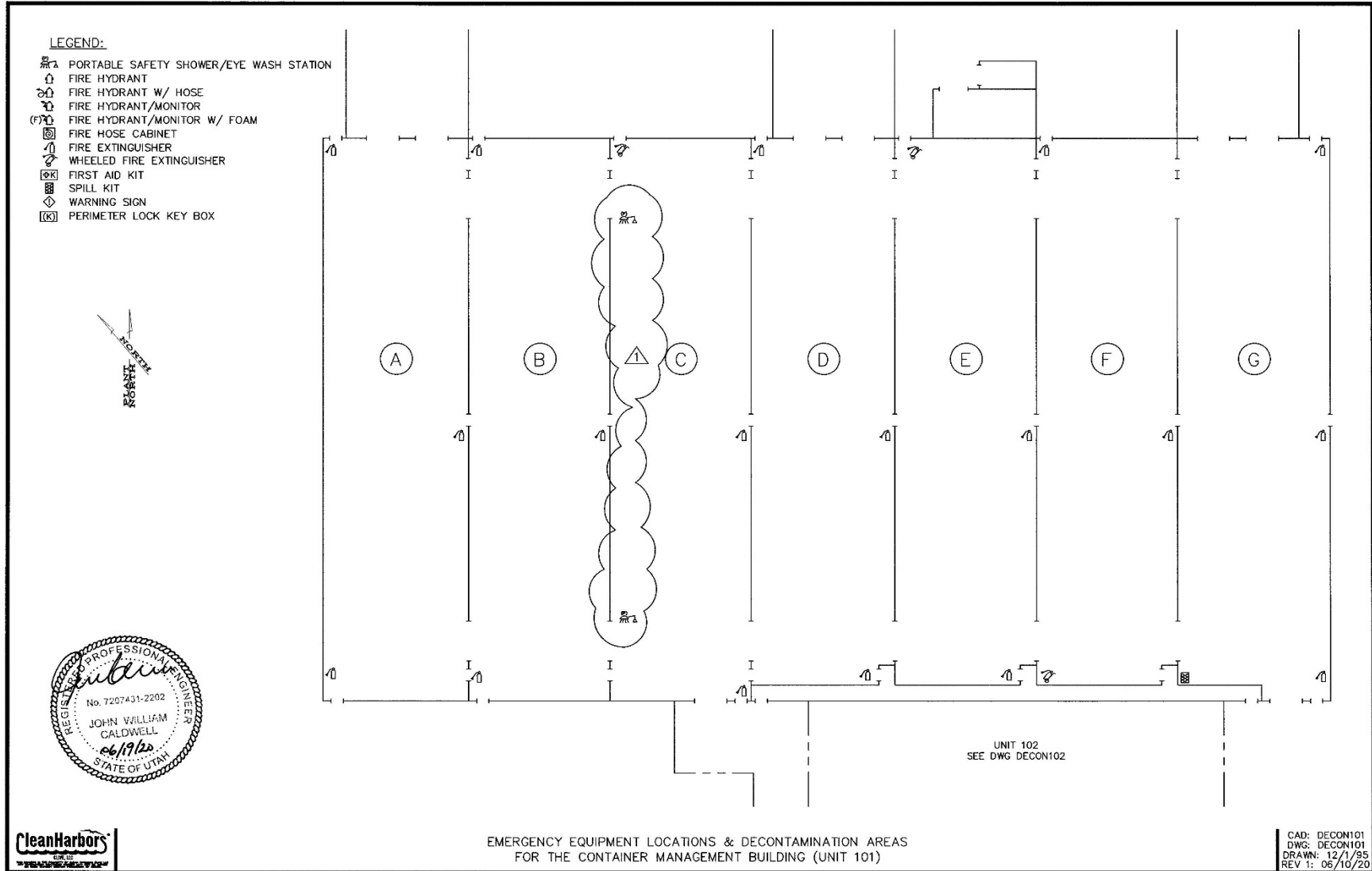

LEGEND:

- ☼ PORTABLE SAFETY SHOWER/EYE WASH STATION
- ⬆ FIRE HYDRANT
- ⊕ FIRE HYDRANT W/ HOSE
- ⊕ FIRE HYDRANT/MONITOR
- (F)⊕ FIRE HYDRANT/MONITOR W/ FOAM
- ☐ FIRE HOSE CABINET
- ⬆ FIRE EXTINGUISHER
- ⊕ WHEELED FIRE EXTINGUISHER
- ☐ FIRST AID KIT
- ☐ SPILL KIT
- ⬆ WARNING SIGN
- ☐ PERIMETER LOCK KEY BOX

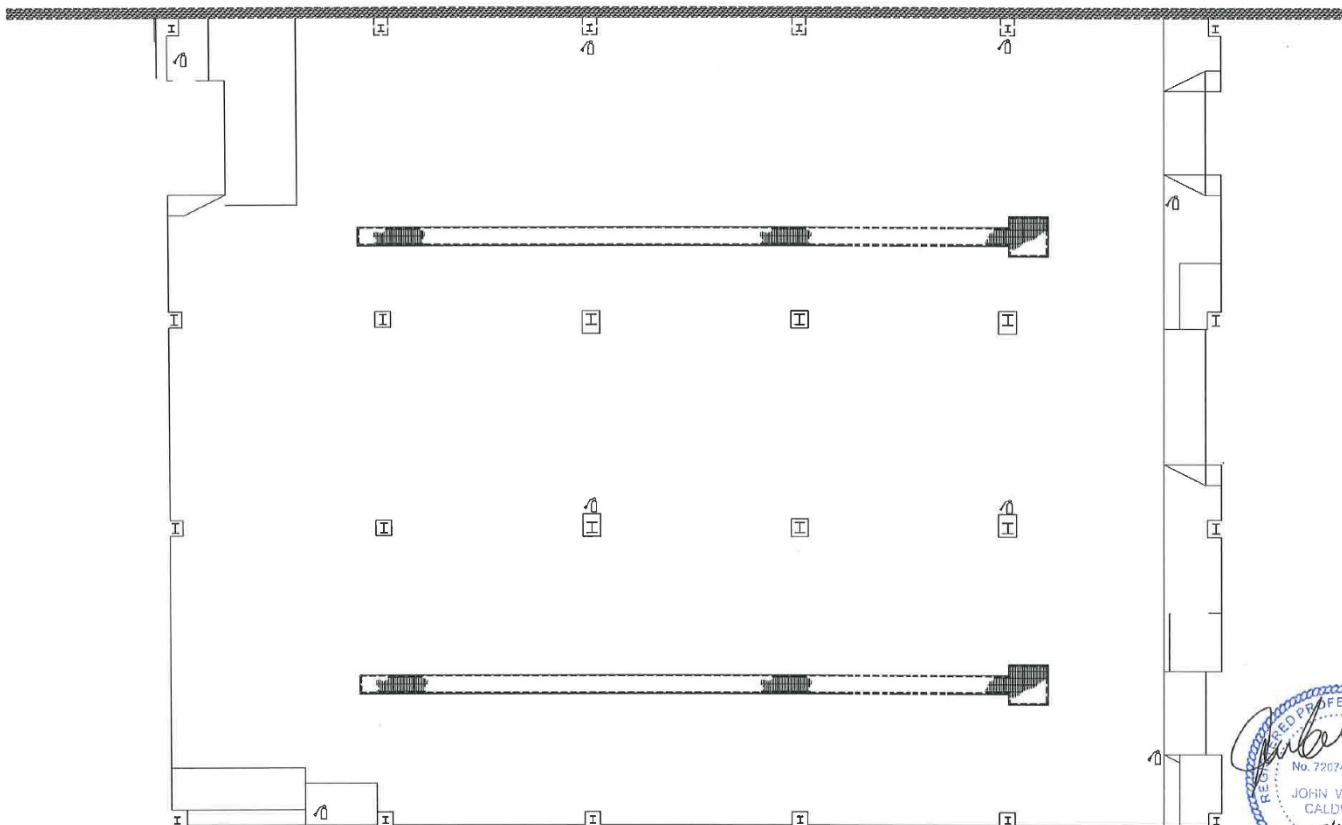





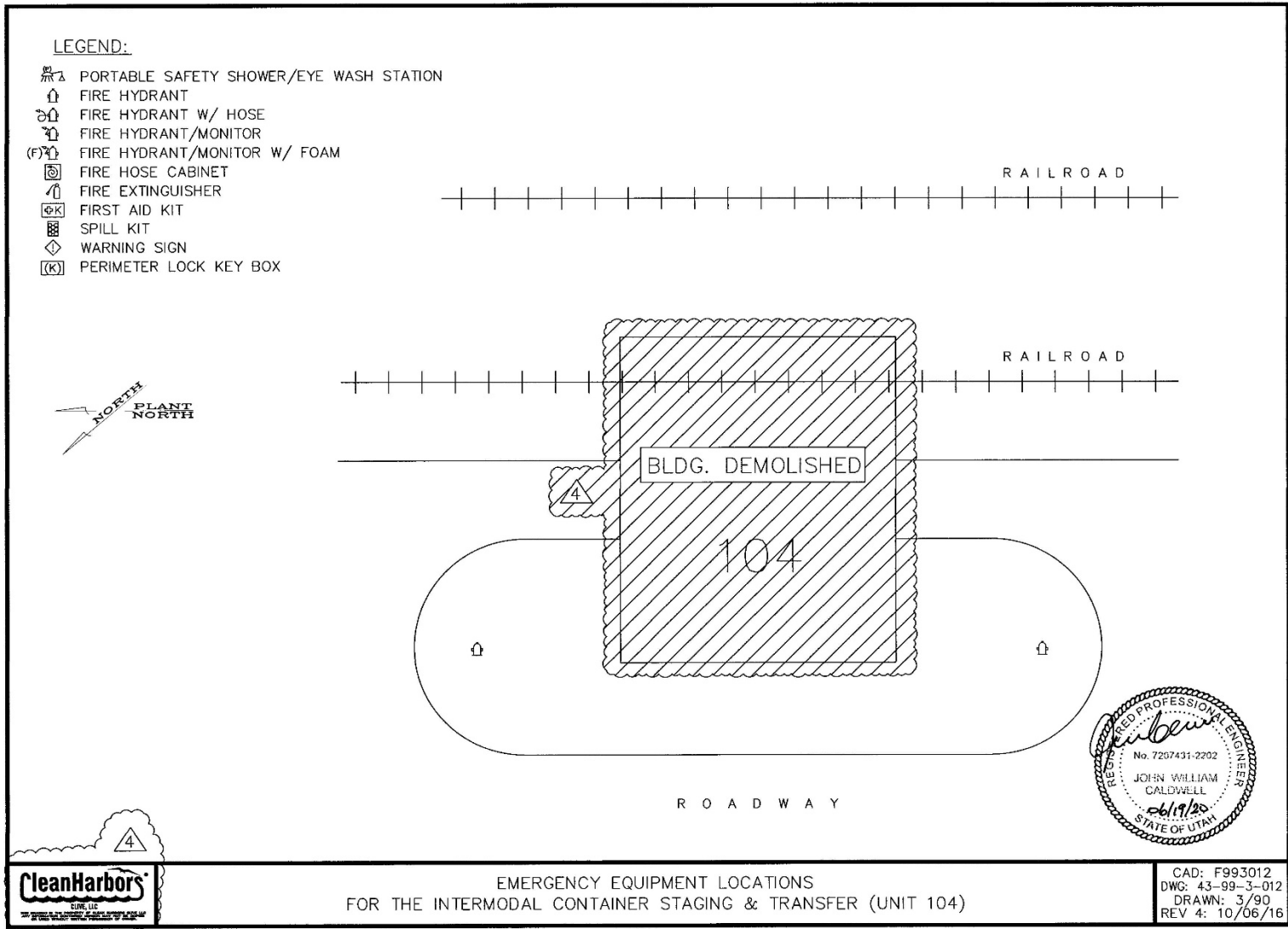





EMERGENCY EQUIPMENT LOCATIONS & DECONTAMINATION AREAS
FOR THE WAREHOUSE BUILDING (BLDG 102)

CAD: DECON102
DWG: DECON102
DRAWN: 05/17/21
REV 0: 05/17/21



LEGEND:

-  PORTABLE SAFETY SHOWER/EYE WASH STATION
-  FIRE HYDRANT
-  FIRE HYDRANT W/ HOSE
-  FIRE HYDRANT/MONITOR
-  FIRE HYDRANT/MONITOR W/ FOAM
-  FIRE HOSE CABINET
-  FIRE EXTINGUISHER
-  FIRST AID KIT
-  SPILL KIT
-  WARNING SIGN
-  PERIMETER LOCK KEY BOX

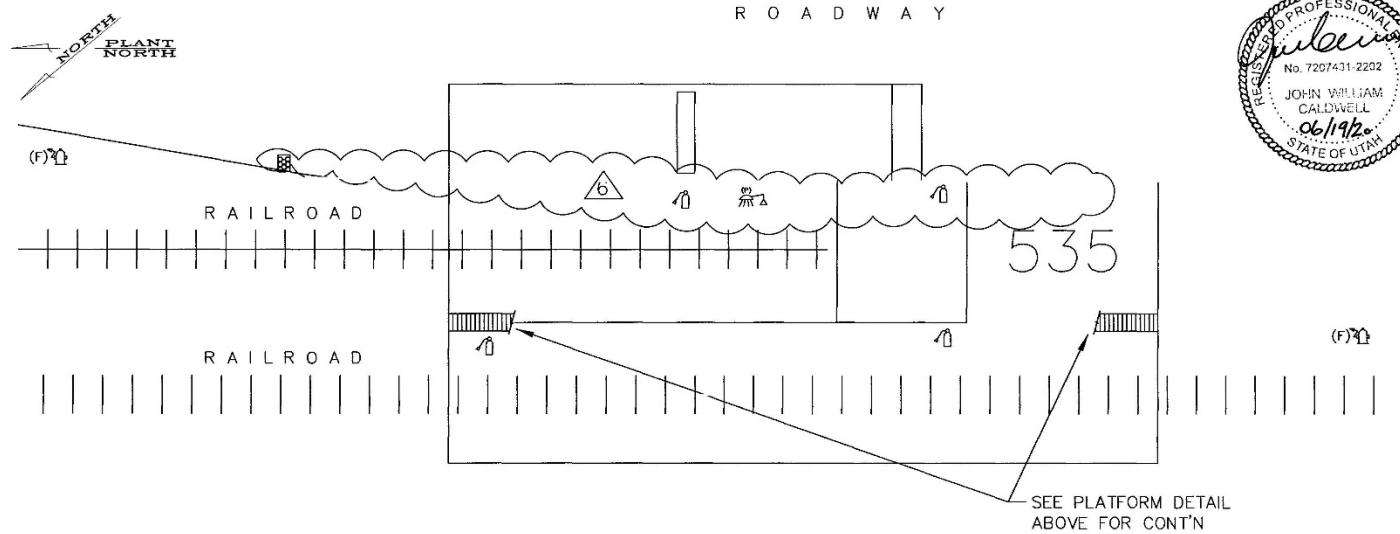
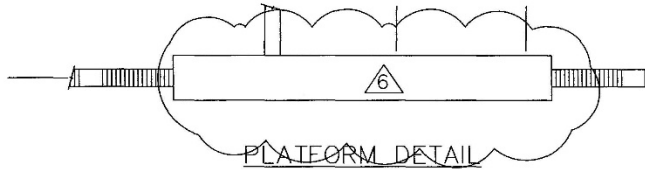

EMERGENCY EQUIPMENT LOCATIONS
FOR THE WASTE FUEL TANK FARM RAIL TANKER UNLOADING AREA (UNIT 535)

CAD: F993023
DWG: 43-99-3-023
DRAWN: 3/90
REV 6: 06/10/20

